



Aerial-51

“SKY-SDR”

HF + 6m SDR
“Autark”
QRP Transceiver



User Manual

Ver. 1.3.1

Appello GmbH
Koenigsfoerderstr. 32
24214 Lindau/Kiel
GERMANY
www.appello.de

TABLE OF CONTENTS

1.	TABLE OF CONTENTS.	2
2.	INTRODUCTION.	3
3.	SPECIFICATIONS	4
4.	ACCESSORY PACKAGE	7
5.	FRONT PANEL CONTROLS.	8
6.	SIDE PANEL CONNECTIONS	10
7.	OPERATION.	11
	• GENERAL OPERATION.	11
	○ SPLIT FREQUENCY OPERATION.	12
	○ MEMORY	13
	• RECEIVE OPERATION.	14
	○ RIT/XIT	8
	○ FILTER SELECTION AND ADJUSTMENT	15
	○ OTHER DSP OPTIONS.	16
	○ RECEIVER BANDSCOPE	17
	• TRANSMIT OPERATION.	17
	• GENERAL TX OPERATION.	18
	○ TX MONITOR	18
	• MODE-SPECIFIC OPERATION	19
	○ SSB OPERATION.	19
	○ CW OPERATION.	19
	○ DIGITAL MODES OPERATION.	20
	○ RTTY OPERATION	20
	○ AM & FM OPERATION	20
8	SOFTWARE MENU MODE SETTINGS	21
	• SOFTWARE MENU QUICK GUIDE.	23
9	SERVICE MODE	24

IMPORTANT MESSAGE

Operating an Amateur Radio Transmitter/Transceiver requires an Amateur Radio License in ALL Countries! Operating the SKY-SDR without a valid Amateur Radio License is punishable by law in ALL Countries.

INTRODUCTION

The **Aerial-51 SKY-SDR** 11-Band, All-Mode transceiver is a synthesis of modern SDR/DSP technology and ease of use. It sports nearly all of the features of much higher priced SDR transceivers, has knobs, is easy to use and **requires no computer for operation.**

The **SKY-SDR** comes with advanced DSP features such as user-definable razor-sharp filters, Noise Reduction (NR), Noise Blanker (NB), Notch Filter (NF) and adjustable AGC timing.

BE CAREFUL when using the radio. A false adjustment of some parameters may lead you to believe the radio is broken!

RESET: If you think the radio may be misadjusted, you may reset most parameters simply by entering the Service Mode, and then immediately exiting the Service Mode. **See Page 24.**

The **SKY-SDR** also incorporates a **BANDSCOPE** which displays 24 kHz above and below the operating frequency. This helps find stations on a quiet band, or locate a free spot on a crowded band.

SKY-SDR's 5 Watt transmitter comes with a hand mike and produces one of the cleanest signals on the air. It includes features such as Speech Processor, Dual-Mode CW/CWR, built-in Keyer supporting A/B modes of keying and full metering of output power and SWR. External amp

keying is available through a dedicated RCA Phono (Cinch) jack.

The **SKY-SDR** has audio equalizing for both RX and TX modes, RIT and XIT, and of course dual VFOs. It includes a USB CAT-Control with FTDI decoder, and LINE IN/OUT for digital modes.

SSB Mode requires pre-adjustment of the speech processor and TX Equalizer for good speech quality.

- - - - -

PLEASE STUDY THIS MANUAL

BEFORE BEGINNING OPERATION

Proper Operation of the SKY-SDR requires the following things:

- **A valid Amateur Radio License** authorizing operation on the HF Amateur Radio bands.
- **A regulated power source** (power supply or battery) supplying nominal 13.8vdc @ 2 Ampere. (Note: 10.5v minimum to 15.0v maximum).
- A (nominal) **50 Ohm Antenna** on the band(s) of operation.
- **OPTIONAL:**
 - Stereo Headphones (4 to 64 Ohms).
 - Morse Code Straight Key or Paddle.

SPECIFICATIONS

GENERAL TRANSCEIVER SPECIFICATIONS		
Technology	Solid State SDR-DSP	Direct Conversion
Frequencies / Bands	1.8 MHz to 54.0 MHz	160, 80, 60, 40, 30, 20, 17, 15, 12, 10, 6m
Modes	AM, CW, DIGI, FM, LSB, USB	CAT: USB2 (FTDI Chip)
Digital Modes	JST, PSK, RTTY, SSTV, etc.	LINE IN/OUT 3.5mm Jack
Output Power	5 Watts (typical)	(fold-back protection for high SWR)
Antenna	50 Ohms (nominal)	BNC Connection
Voltage Requirements	10.5vdc (min) to 15vdc (max)	Fuse: 3.15A, 250V, Slow Blow
Current Drain	RX: Average 360mA TX: Maximum 2A	RX 40mA less with the backlight switched off
Frequency Stability	±3 ppm	0 to 50 degrees Centigrade
Memory	100 slots (0-99)	stores freq., mode, VFO (A/B) & other functions
Loud Speaker	1/4 Watt	
Display Backlight	Always On, Always OFF, Automatic (off after 3 seconds)	
Enclosure Size	12.8 x 10.7 x 5.5 cm	(excluding knobs and connectors)
Working Size	14.7 x 10.7 x 7 cm	(including knobs and connectors)
Weight	580 grams (20.5 oz.)	(without mic)

TRANSMITTER SPECIFICATIONS		
Output Power	5 Watts (typical) / adjustable	(fold-back protection for high SWR)
TX Metering	Selectable: Output Power or SWR	Selectable: Numerical or Bar Graph
D.C. Voltage Metering	Numerical display	
VOX	Adjustable Gain & Delay	
Compressor	Adjustable 0-20dB	
Reverberation	Adjustable	
SSB TX Mute	Disable = Monitor / Enable = Mute	
Key Type	Selectable: Automatic = Paddle / Manual = Hand-Key	
Built-In Keyer	Iambic Mode A or Mode B	Menu selectable
Keyer Adjustments	Speed / Weight	Menu adjustment
CW Sequencing	Adjustable Delay	From 100ms to 5 seconds
Digi Mode Gain	Adjusts audio gain in digi mode	
AMP Key (PTT JACK)	Keys External Amplifier	
TX DSP FILTERS	1 Filter per Mode	
SSB TX Filters	Bandwidth: 2.800 kHz	Adjustable
CW TX Filters	Bandwidth: 100 Hz	Adjustable
AM TX Filters	Bandwidth: 5.590 kHz	Adjustable
FM TX Filters	Bandwidth: 9.600 kHz	Adjustable
DIGI TX Filters	Bandwidth: 3.350 kHz	Fixed
TX Bandscope	Monitors transmitted signal	

RECEIVER SPECIFICATIONS		
Technology	Solid State SDR-DSP	Direct Conversion
Sensitivity	0.2 uV	With Preamp On
Preamp	+16 dB	
Attenuator	-6 dB	
Pre-Filtering	7 LPF and 7 BPF (cascaded)	160m, 80m, 60+40m, 30+20m, 17+15m, 12+10m, 6m
Spurious Response Rejection	IMD3: -48 dB	
Current Drain	Backlight: ON / OFF	Avg. 360mA / 320mA
RX Bandscope	±24 kHz	
DSP RX Filters	4 filters (most modes) 1 is user definable	push-button selection
SSB Filters (4)	4 Filters: <ul style="list-style-type: none"> • 3 Fixed Filters • 1 User Adjustable Filter 	From 250 Hz to 3600 Hz
CW Filters (4)		From 20 Hz to 1200 Hz
AM Filters (4)		From 2.0 kHz to 9600 Hz
FM Filters (4)		From 2.0 kHz to 9600 Hz
DIGI Modes (1)	Bandwidth	Fixed: 3.35 kHz
DSP Noise Reduction	Adjustable Level (1 to 50) use lowest level necessary	
DSP Noise Blanker	Adjustable Level (4 to 12) Adjust for minimum interference	
DSP "ACE"	Automatic Carrier Eliminator, SSB mode (only), (greater -40dB) {This is an improved Notch Filter }	
S-Meter	Bar Graph or uV readout	
CW Mode Selection	CW or CWReverse	Menu selectable
Squelch	Adjustable for FM & Other Modes	0 to 100 / "0" = Off

ACCESSORY PACKAGE

The SKY-SDR ships with the following accessories:

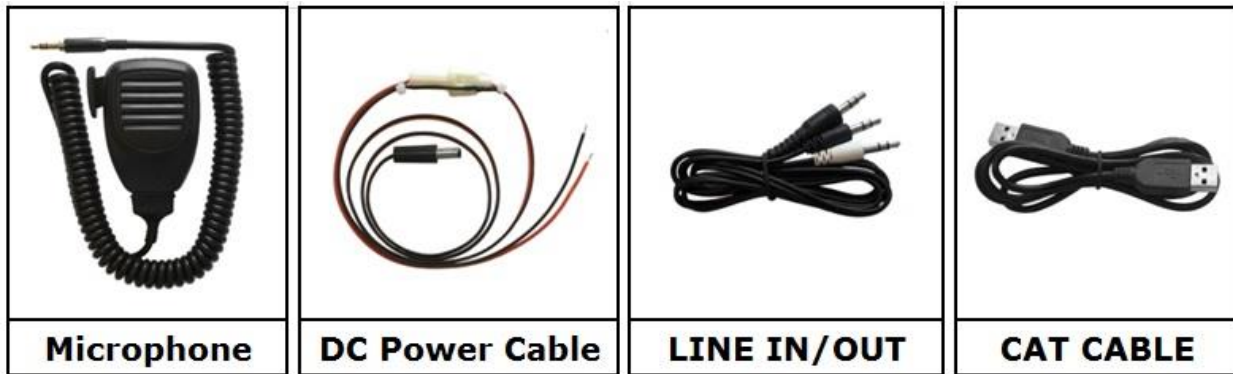

Microphone: An electrets mic that draws its power from the mic line (tip). If you use a dynamic mic, you must insert a 350 to 400 nF capacitor between the mic capsule and this line.

DC Power Cable: Red (+) and Black (-) power cable with in-line fuse holder and coaxial power plug (2.5mm x 7mm).

Spare Fuse: (not pictured) a spare fuse is included in the accessory package. It is a 5mm x 20mm fuse, 3.16A, 250V Slow-Blow.

USER MANUAL

CAT CABLE: This is a standard computer USB2 cable with type A plugs on both ends.

2 ALLEN WRENCHES: (not shown)

LINE IN/OUT: This is a special cable which splits the input audio and output audio from a single common plug and connects each to its own dedicated plug.

All three plugs are 3.5mm phone plugs. See pinout below:

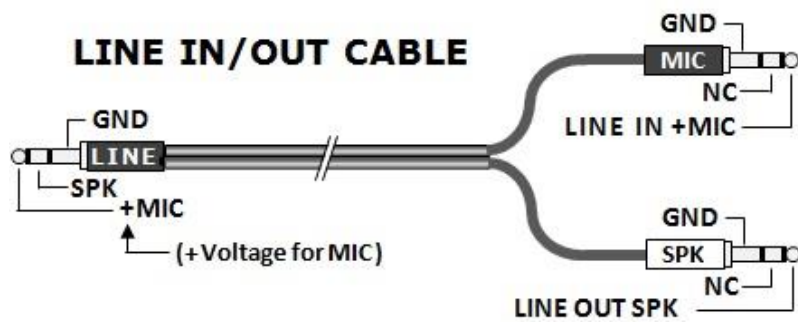

FRONT PANEL CONTROLS

1. VFO-TUNING / Multi Knob;

Adjusts frequency in operation mode.

Adjusts menu value in Menu mode.

2. AF Gain Control

3. Power ON/OFF

4. PRE/ATT – pushing button toggles through Preamp, Attenuation, or None.

5. STEP – selects the step size (tuning rate) when turning the VFO knob.

STEP	SSB DIGI	CW	AM/FM
1	10 Hz	1 Hz	100 Hz
2	100 Hz	10 Hz	1 kHz
3	1 kHz	100 Hz	10 kHz
4	10 kHz	1 kHz	100 kHz

6. MODE/NF – pushing this button toggles through the modes (USB, CW, etc.). **In SSB Mode (only):** when the [F] button is pushed, followed by the Mode button, it toggles the Notch Filter on or off. It is always off in all other modes. This is also called "ACE".

7. FILTER – pushing this button steps through the selection of bandwidth filters 1, 2, 3, or 4.

8. LOCK/TX – (TUNE) **In CW Mode, Reduce Power to 25%.** Then push PTT or key CW; while transmitting, push this button to lock in TX Mode. Push button again to unkey the transmitter.

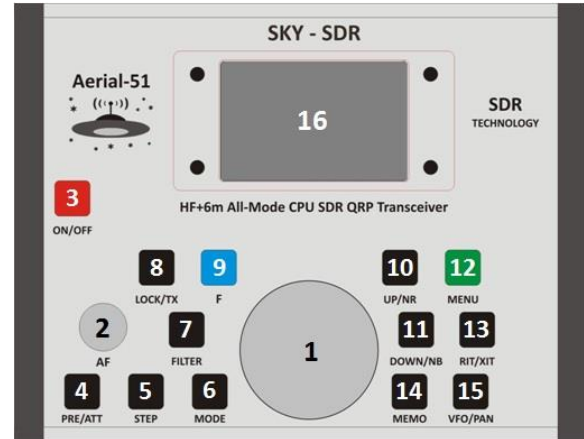

9. [F] – **Function Button**; pushing this button activates the 2nd layer of functions for several button.

10. UP/NR – in operating mode, pushing this button changes the band to the next higher band. In MENU mode, pushing this button selects the next higher menu item. Push [F] and this button to activate the **DSP Noise Reduction**.

11. DOWN/NB – in operating mode, pushing this button changes the band to the next lower band. In MENU mode, pushing this button selects the next lower menu item. If pushed after pushing [F], it activates the DSP **Noise Blanker**.

12. MENU – Pushing this button enters the software Menu Mode.

13. RIT/XIT – Pushing this button **while in RX mode** enables Receive Incremental Tuning (RIT). Disable by pushing [RIT] again.

14. **To enable XIT, you must first be in TX mode** (i.e. push PTT in SSB or key a long dash in CW), then push the [RIT/XIT] button. To

disable TX Incremental Tuning (XIT), push **[RIT]**.

In some menu items, this button also is used to toggle between multiple parts of the item (i.e. defining filter settings, etc.).

- 15. **MEMO** - Pushing this button enables storing and recalling memory locations.
- 16. **VFO/PAN** - Pushing this button toggles between VFO-A and VFO-B. Pushing **[F]** and then this Button enables turning the PAN-ADAPTER on and off. Select with VFO knob.

17. **DISPLAY** - LCD display size is 43.5 x 40.9mm (1.7" x 1.6"). It has very low power consumption.

The pictures (below) describe most of the features which are displayed on the SKY-SDR display.

NOTE: "IF" in the lower right corner must ALWAYS be "on" and normally showing. When the Pan-Adaptor is on, the "IF" cannot be seen but it must still be on. If it is ever "Off", push [F] + [RIT/XIT].

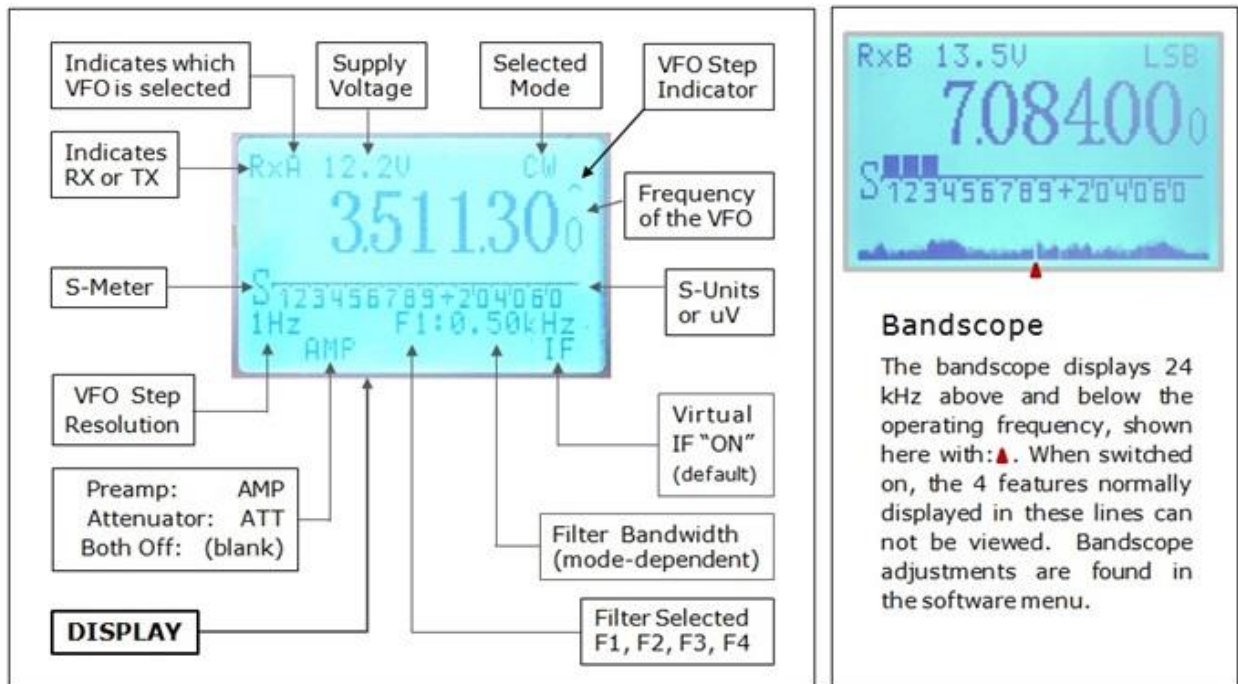

NOTE: "IF" (Virtual Intermediate Frequency) MUST ALWAYS BE "ON".

When the virtual IF is OFF, receiver performance is significantly degraded.

If it is ever off, press [F] and then [RIT] to switch it back on. When the Bandscope is on, it covers the bottom line of the screen and you cannot see "IF".

SIDE PANEL CONNECTIONS

LEFT SIDE PANEL



Left Side Panel

KEY: The SKY-DSR accepts either a Straight Key or Paddle. Both connect to the 3-pole, 3.5mm key jack.

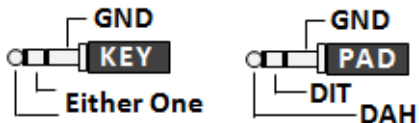

MIC: The SKY-DSR comes with a condenser (electret) hand Microphone using a 3.5mm phone jack. To use a dynamic MIC, you must insert a 330 to 470 nF capacitor in series with the +MIC line.

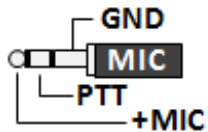

PHONE: The SKY-DSR accepts stereo headphones with a 3.5mm phone jack. Any common stereo headphones with an impedance of 4 to 64 Ohms will work; the lower the better.

MON / SIDETONE: Adjust sidetone volume level (through the hole) with a tiny screwdriver.

RIGHT SIDE PANEL



LINE IN/OUT: Used for connecting to external sound card interface. See accessories page for pinout. Audio level is independent of volume control.

Right Side Panel

DC: Power is applied through a 2.5mm x 7mm coaxial DC power plug.

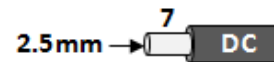

ANT: A female BNC jack accepts nominal 50 Ohm antennas.

CAT: CAT control is via a 'type A' USB2 connection. (FTDI Chip).

PTT: Push-To-Talk, open collector keying circuit, used to key a linear amplifier through an RCA phono plug. (Also called Amp Key). Delay time is adjustable in the **software menu #4 (CW VOX)**.

SPKR: Loud-Speaker, automatically mutes when you plug headphones into the phone jack.

OPERATION / GENERAL

BEFORE YOU BEGIN

- Assure that your antenna is in good working order and connected to the radio.
- Switch ON the power supply or connect battery leads BEFORE switching the radio on.
- Check that the supply voltage is within the specified working range required for proper operation. (+10.5 to +15.0 vdc).
- Reduce the audio gain (turn gain control almost fully counter clockwise).
- Turn the radio ON and observe the dial. The Aerial-51 logo should appear for 3 or 4 seconds, and then the radio switches to operate mode.

GENERAL INFORMATION

The SKY-SDR has only two primary controls: the audio gain knob and the VFO knob.

Audio Gain Knob: This is a mechanical control with only one function – to control the audio output level to the speaker or headphones. Full Counter ClockWise (CCW) is the lowest gain setting, full ClockWise (CW) is the maximum gain setting. The position of this control does not affect the audio output level on the LINE IN/OUT jack.

VFO Knob: The VFO knob is used for multiple functions:

1. Changing the operating frequency.
2. Changing software menu values when operating in Menu Mode.
3. Changing the Receive Incremental Tuning (RIT) frequency or Transmit Incremental tuning (XIT) when either of these functions is enabled.

Explanation of each of the VFO function:

1. Turning the VFO knob is the basic means of changing the operating frequency. Turning the knob in the CW direction increases the frequency, and turning it in the CCW direction decreases the frequency.

There are two modes of tuning operation that may be selected by the **software menu item #1 (Valcoder)**. Either “variable” speed tuning (Smart Valcoder Enabled) or “fixed” speed tuning (Smart Valcoder Disabled) may be selected. In variable speed tuning mode, the rate of change of frequencies varies with the speed of which you turn the VFO knob.

2. Most software menu items have variable parameters that are adjustable with the VFO knob. For instance in RX mode you can vary the level for the Noise Blanker or the Noise Reduction, etc. For TX you can vary the level of the speech processor or the speed of the automatic keyer in CW, etc.

Some menu items are simply switched (toggled) between 2 or 3

positions, such as selecting whether to show Output Power or SWR in TX mode, or whether to show S-Units or uVolts in RX mode, etc.

For a more detailed explanation, see the **Menu Mode Settings** on page 20.

- When **RIT** is enabled by pushing the "**RIT**" button, rotating the VFO knob changes only the Receive frequency, it does not change the Transmit frequency.

You must be in TX mode to enable XIT. Press PTT and then press the RIT button. Rotating the VFO knob changes only the Transmit frequency, it does not change the Receive frequency.

In RIT mode, the change in frequency when rotating the VFO knob can be observed on the top right of the **DISPLAY**, as seen here:

STATUS	 ←----- DISPLAY -----→ 	COMMENTS
• RIT OFF:	RxA 13.1V LSB	
• RIT ON:	RxA 13.1V RIT * LSB	RIT = 0
• RIT ON:	RxA 13.1V RIT < LSB	RIT lower than VFO QRG
• RIT ON:	RxA 13.1V RIT > LSB	RIT higher than VFO QRG

When RIT and XIT are both off, there is nothing displayed. Turning either one "ON" will show the "RIT" (or "XIT") in the space between the voltage and the mode as shown under DISPLAY above. The symbol after RIT (or XIT) shows which way the incremental tuning is moving.

<=down -or- >=up.

There is no function to re-sync the RIT with the VFO's frequency. If you wish to do so, you must manually tune it until the asterisk (*) appears.

To exit RIT or XIT, simply push the button again.

For simplicity, the button labeled **[VFO/PAN]** will be referred to simply as **[VFO]** and **[RIT/XIT]** will be referred to as **[RIT]**.

The **SKY-SDR's SPLIT** is totally simple to use, but somewhat different than with other radios. Before enabling SPLIT, you should set both VFOs where you want them to be after SPLIT is enabled – typically one on the RX frequency and the other on the TX frequency.

SPLIT Mode is entered **while in RX mode** by pressing **[RIT] + [VFO]**. These two buttons are next to each other so the operation takes just 1 second to execute.

SPLIT FREQUENCY OPERATION

Fundamentally, the radio has two independent VFOs on each band and the frequency each is tuned to before enabling SPLIT will be its TX frequency after entering SPLIT Mode. To toggle between VFOs as always: simply push **[VFO]**.

IMPORTANT: Even though one VFO will be on the desired RX frequency, you will NOT use it for receiving. For receiving you must use the VFO that is showing the desired TX frequency and tune it manually back to the RX frequency.

To **EXIT SPLIT** at any time, simply by push **[RIT]**.

This will be clearer in the example below:

SPLIT OPERATION EXAMPLE:

- **"DX1DX"** is calling CQ on 14.150 MHz and requesting callers "UP 5".
- You are receiving on **VFO-A**.
- **PRESS THE [VFO] BUTTON.** The radio switches to **VFO-B**.
- Tune **VFO-B** to 14.155 MHz (5 kHz above DX1DX's frequency).
- Now **PRESS** the **[RIT]** BUTTON – as if you were normally turning on RIT. You notice the "*" appear in the top right of the display.
DO NOT TURN THE VFO KNOB.
- **IMMEDIATELY PRESS THE [VFO] BUTTON** to switch into **SPLIT** Mode displaying 14.155 MHz. **THIS is now the TX frequency.** The TX is locked on this frequency. The VFO knob now tunes the RX frequency.
- **Tune back to 14.150 MHz and find DX1DX again. READY!**
- Your radio is now working split. Confirm by pushing the Mic's PTT button and watching the display.

When you transmit, the frequency switches to 14.155 MHz. When you release the PTT button it returns to RX and 14.150 MHz.

- You may switch to VFO-A at any time and you will be receiving and transmitting on 14.150 MHz (CAREFUL: if you transmit on VFO-A, you are transmitting on the frequency of DX1DX). If you tune the VFO knob, it will change the RX frequency but when you transmit, you will transmit on 14.150.

To **EXIT SPLIT**, just push the **[RIT]** button while in RX Mode.

Practice using this feature 2 or 3 times before you need it. You will soon see that although it is different, it is very easy to use!

MEMORY

The SKY-SDR has 100 memory locations, labeled from 0 to 99. Other information such as mode, filter bandwidth, AGC settings, etc. is also stored together with the frequency.

STORING DATA IN MEMORY:

- **Tune the VFO** to the frequency to be stored and make sure that other settings such as mode, bandwidth, AGC, etc. are as you wish to store them.
- **Press [MEMO]** to switch to Memory Mode.
- **Rotate the VFO** Knob to the memory slot (0 to 99) in which you wish to store the data.

- **Press [DOWN]** to download the data into the selected memory location.
- **Press [MEMO]** to store the data, exit Memory Mode, and return to normal operation.

RETRIEVING DATA FROM MEMORY:

- **Press [MEMO]** to enter Memory Mode.
- **Rotate the VFO Knob** to the memory location (0 to 99) that contains the data you wish to retrieve.
- **Press [UP]** to upload the data to the VFO.
- **Press [MEMO]** to exit Memory Mode and return to normal operation.

NOTE: Each time you power on the radio, the first time you enter Memory Mode, it defaults to memory location 0.

TIP: Do not store favorite frequencies into memory location 0. Leave 0 free and use it as a scratch pad.

During normal operations, if you wish to temporarily store something to retrieve a short time later, store it into memory location 0. That way it is easier to find the temporary data later.

BAND SELECTION

Band selection is accomplished by using the UP or DOWN arrows, just to

the right of the VFO knob. The band order is:

**160m | 80m | 60m | 40m | 30m | 20m
| 17m | 15m | 12m | 10m | 6m**

With each press of a button, the radios steps up or down by one band.

DISPLAY BACKLIGHT

Software **Menu item #15 (LED Mode):** The options are: OFF, Always ON, or automatic (off after three seconds). When off, it saves about 40 mA of current.

RECEIVE OPERATION

MODE SELECTION

There are two groups of modes:

- **CW | CWR | DIG | AM | FM | USB | LSB**
(AM/FM Enabled)
- **CW | CWR | DIG | USB | LSB**
(AM/FM Disabled)

You can choose which group you prefer in **Menu item #16 (in Menu Mode)**.

NOTE: each band can and must be adjusted separately. Selection is stored by band. Turning AM/FM "OFF" on the 160 through 12m enables faster stepping through the usable modes on these bands.

FILTER SELECTION AND ADJUSTMENT

The SKY-SDR has 4 filters per mode in AM/CW/FM/SSB (F1, F2, F3, & F4).

There is only one filter for **DIGI mode** with a fixed bandwidth of 3.35 kHz.

On **all other modes**, F1, F2 & F3 are fixed bandwidths and are not user adjustable. F4 is user-adjustable to any convenient bandwidth and may be adjusted without exiting Operating Mode.

The bandwidth of the selected filter is shown in kHz on the display, preceded by the filter number. Example:

“F1: 2.9 kHz” or “F4: 0.1 kHz”.

In **CW and SSB modes** you can also change the passband center frequency as well as the bandwidth. This is not necessary in AM or FM.

In **CW mode**, this is accomplished by setting “CW PITCH” in **Menu Mode item #2**. The bandwidth of the filter selected is then centered on that frequency.

In **SSB mode** (LSB or USB), this is accomplished by setting the Lo-Cut and Hi-Cut frequencies; the bandwidth is then the difference between these two frequency, the passband center is the determined by the Hi-Cut frequency minus half of the passband bandwidth.

Example follows below.

F4 Filter Adjustment:

For **AM/FM & CW**, filter adjustment is simple. While in operate mode:

- Select the filter F4.
- Press **[F]** (blue button)
- Press **[Filter]** (the current bandwidth appears)
- Rotate the VFO knob to adjust the bandwidth (CW=wider, CCW=narrower). Changes are

heard in real-time, but not yet saved.

- Once the desired bandwidth is set, save the change by pressing the “Filter” button again.

EXAMPLE-1: Say we want a 100 Hz **CW filter** centered on 650 Hz:

- Select CW Mode
- Select filter “F4”
- Press **[F]**, then press **[Filter]**
- Using the VFO knob, set the bandwidth to 100.
- Set the center frequency of the passband for the CW filter in **Menu Mode item #2 (CW Pitch)**.

Push “MENU”, then using the UP or DOWN arrows, scroll to **Item #2 (CW Pitch)**. Adjust the VFO knob to 650. Press [MENU] to exit and save settings.

The **SSB F4** filter’s bandwidth and passband are also easy to adjust.

The filter is adjusted by re-defining the “Low Cutoff Frequency” and “High Cutoff Frequency” of the filter’s passband. The parameters are set as follows:

- Bandwidth: difference between the two frequencies (Hi Freq. – Lo Freq.).
- Passband Center: Hi Freq. minus half the bandwidth frequency.

EXAMPLE-2: Say we want an SSB filter 1.8 kHz wide, centered on 1.5 kHz:

- Select USB Mode

- Select filter "F4"
- Press **[F]**, then press "Filter"
- Press **[RIT]** to toggle between Lo- and Hi- adjustments – Use VFO knob to adjust frequency.
- Set Lo-Freq. to 600 Hz ; Set Hi-Freq. to 2.4 kHz
- Passband Center is: 2400 Hz minus 600 Hz = 1500 Hz

Digital Modes: Most DIGI modes are operated in DIGI Mode with a fixed filter bandwidth of 3.35 kHz. For RTTY, use USB Mode.

OTHER DSP OPTIONS

Noise REDUCTION <NR>: The NR is used to help reduce the level of received broadband noise. It is engaged by pressing **[F]** and then pressing the **[UP/NR]** button. The NR should be left OFF unless absolutely necessary, as it will slightly distort received audio when ON.

The level of noise reduction of the NR may be adjusted in the software **menu item #2**, with a range of 1 to 100. 1 is minimum and 100 is maximum. You should only use as high of level as deemed necessary. This helps keep audio distortion to a minimum. To deactivate the NR, press **[F]** and **[UP/NR]** again.

NOISE BLANKER <NB>: The NB is useful for reducing the level of short pulse noise, such as static crashes or pulses generated from an electric fence. It is engaged by pressing **[F]** and then pressing the **[DOWN/NB]** button. The level of blanking can be adjusted in the Software **Menu item**

#10, with levels ranging from 4 to 12. In this case, 4 is maximum blanking and 12 is minimum blanking. Always set this level as high as possible while still achieving the necessary blanking. To deactivate the NB, press **[F]** and **[DOWN/NB]** again.

NOTCH FILTER <NF>: The NF ("ACE") is used for eliminating carriers/heterodynes while operating in SSB mode (only). It does not work in any other mode. It is activated by first pressing the **[F]** button and then pressing the **[MODE]** button. To deactivate NF, press **[F]** and **[MODE]** again.

RECEIVER SENSITIVITY

There are 3 levels of sensitivity: **NORMAL; ATTENUATION; and PRE-AMPLIFIER**. Toggle through these 3 levels by pressing the **[PRE/ATT]** button. The level selected is shown in the bottom line of the display as: "AMP" for Preamp; "ATTN" for Attenuator; or blank (nothing shown) when in "NORMAL" mode.

AGC TIMING: The attack and recovery time of the AGC is set in the Software **Menu Item #9**. The range is from 1 (slowest) to 20 (fastest). Use slower speeds for SSB and faster speeds for CW and digital modes.

S-METER OPTIONS

The S-Meter is only accurate when the Pre-Amp is "ON". The signal strength of the received station may be displayed in S-Units

on the bar-graph display, or numerically in uVolts. The S-Meter mode is set in the **MENU Item #11**. Note: with Pre-Amp "Off", the S meter will read about 3 S-Units lower than the actual signal strength.

AUDIO OPTIONS

AUDIO EQUALIZER: The received audio may be adjusted in three frequency ranges: Low/Medium/High. It is adjusted in the Software **Menu item #26 (EQ RX)**. Once #26 has been selected, you may step through the three ranges by pressing the **[RIT]** button. The level is adjusted using the VFO knob. The range is 1 to 10 with 1 deemphasizing the range (minimum) and 10 emphasizing the range (maximum). Adjust to suit your own preference.

SQUELCH-FM: The squelch level for FM is adjusted in the Software **Menu item #17**. The range is 0 to 100. When set to 0, the squelch is off. Adjust to suit your own preference.

SQUELCH-SSB/CW: The squelch level for SSB and CW is adjusted in the Software **Menu item #18**. The range is 0 to 100. When set to 0, the squelch is off. Adjust to suit your own preference.

RECEIVER BANDSCOPE: is useful for spotting clear frequencies on a very crowded band, or locating signals on a quiet band. It is switched ON or OFF by pressing **[F]**, then the **[VFO/PAN]** button. The Pan Level is adjusted in the Software **Menu item #27**.

TRANSMIT OPERATION

GENERAL ADJUSTMENTS

TRANSMIT DISPLAY MODE: The SKY-SDR can monitor Output Power or SWR. The mode is selected in the Software **Menu item #13 (Show TX)**.

TRANSMIT DISPLAY METHOD: The SKY-SDR can display the output power or SWR on a Bar Graph or as a numerical value. The display method is selected in the Software **Menu item #12 (TX Meter)**.

TRANSMIT POWER: The output power of the transmitter is adjusted in **Item #14 (Power TX)** of the Software Menu. The range is 10 (approx. 1W) to 100 (approx. 6W).

FOLDBACK PROTECTION: when the SWR is high, the power is reduced to protect the final amplifier transistors. Above an SWR of 2:1 it reduces the output power to 3 Watts. By 10:1 SWR it is reduced to just 1 Watt.

TX AUDIO ADJUSTMENTS:

TX AUDIO EQUALIZER: The TX audio may be tailored with the help of a built in 3-band equalizer: Low, Medium, and High frequencies. It is adjusted under the Software **Menu item #25 (EQ TX)**. The bands are selected by pressing the RIT button and the level for each range is adjusted with the VFO knob. The range is from 1 (deemphasize) to 10 (maximum

emphasis). **RECOMMENDED:**
Low=10, MED=6 and HIGH=6.

SPEECH COMPRESSOR: The level of compression is set in the Software **Menu item #23 (Compress TX)**. The range is from 1 (minimum) to 100 (maximum compression). Setting it to 1 effectively turns it off. **In most cases, a level of 40 to 50 is required for the factory hand-mic.**

REVERBERATER: The radio also has a built in reverberator that enables enhancing the transmitted audio slightly. CARE MUST BE TAKEN when using this feature. A very small amount of reverberation can enhance the signal but too much makes it difficult to copy.

Default is "DISABLE". Rotate the VFO clockwise to enable and select delay times: (40ms, 80ms, and 160ms). Press RIT to toggle to Depth, Level, and back to delay times. Depth and Level may be adjusted from 1 to 7.

Before using this feature on the air, you should experiment with the adjustments while transmitting into a dummy load and having a friend listen to your signal on a nearby receiver.

TRANSMIT GAIN

Mic-Gain is fixed and optimized for the hand Mic. Adjust compressor for best audio level. (set about 50)

DIGI MODE GAIN is adjusted in the **Menu item #20 (Gain TX DIG)**.

TX MONITOR: You may monitor your own TX audio in headphones while adjusting the audio settings. This is enabled in the Software **Menu item 19**

(SSB TX MUTE). "Enable" mutes (turns off) this feature. "Disable" turns it on.

MODE-SPECIFIC OPERATION

SINGLE SIDEBAND OPERATION

For information on adjusting Mic Gain, Audio Equalizer, Speech Processor, Reverberator, and TX Monitor, see OPERATION TRANSMIT – GENERAL ADJUSTMENTS on pages 16 and 17.

VOX-GAIN: The level of VOX gain is adjusted in the **Software Menu item #21 (Voice VOX Level)**. Here you can adjust the sensitivity at which the VOX switches to TX Mode. The range is from 10 (most sensitive) to 100 (least sensitive).

VOX-DELAY: The VOX delay or "hang time" is adjusted in the **Software Menu item #22 (Voice VOX)**.

BANDSCOPE: The TX Bandscope works independently of the RX Bandscope turning on the RX scope does not automatically turn the TX Bandscope. Enable TX Bandscope by depressing the PTT button on the MIC, then press **[F]** and then **[VFO/PAN]**.

The Bandscope display remains empty until you speak into the mic.

Adjust Pan Level in **Software Menu item #27**.

CW OPERATION

CW MODES

There are two modes of CW operation, **Normal (CW)** and **Reverse (CWR)**. There is no agreed standard on which mode to use. In some cases where

there is strong QRM from one side, you will get better reception by switching to the opposite mode. The CW Mode is selected in the **Software Menu item #8 (Reverse CW Key)**.

SIDETONE LEVEL

The sidetone level adjustment is a mechanical adjustment. The level is adjusted using a small screw driver through a hole on the left side panel. See "Side Panel Connections" (and adjustments) on page 10.

The SKY-SDR has several features for CW Mode. In order to enable transmitting in CW, you must select a delay time in **Software Menu item #3 (CW VOX)**. Default is "Disabled." The minimum delay is 100 ms. The maximum is 5 seconds.

When using the radio with an external amplifier, 100 ms is OK with many newer amps. When using with amps that have a slow open-frame T/R relay (i.e. most Ameritron amplifiers), you will need 200 or 300 ms to prevent the amp's slow T/R relay from trying to follow the keying with every dit or dah.

CW-PITCH: The CW Pitch control sets the frequency of the center of the bandpass of the filters; thus it defines the frequency which will sound the loudest when tuning across CW stations. When you adjust the CW Pitch, it automatically adjusts the transmit offset frequency such that you will be zero-beat with the other station when you are listening to a tone with the pitch you set.

EXAMPLE: If you set the Pitch for 700 Hz and listen to a 700 Hz tone, you will

be zero beat. If you listen at 600 Hz, you will be 100 Hz off frequency.

CW KEY SELECTION: The SKY-SDR will operate with a simple straight key, external keyer, or using its own built-in iambic keyer.

For operation with a **straight key**, wire the 3.5mm Phone plug as shown on page 10 on the left (KEY).

For operation with an **external keyer**, connect the keying line using a 3.5mm Phone plug wired just like the straight key.

For operation with the **built-in iambic keyer**, wire the paddle as shown on page 10 on the left (PAD).

BUILT-IN IAMBIC KEYS:

The built-in keyer has several Software Menu adjustments:

- **Iambic Mode – (Software Menu item #6)**. Toggles the built-in keyer between Mode A and Mode B. **In Mode A** when releasing the paddle, the keyer completes the element being sent. **In Mode B** the keyer sends an additional element opposite to the one being sent when the paddle was released. Different users have different preferences. If you are not already familiar with Mode B, you should select Mode A.
- **CW [Keying] Speed – (Software Menu item #5)**. Adjusts keying speed of the keyer between 5 and 50 wpm. The change takes place after you exit the Menu Mode.
- **Weight – (Software Menu item #7)**. This adjusts the dot-to-dash ratio. Default is 3:1. Other

selections are: 2:1, 2.5:1, 3:1, 3.5:1, 4:1, and 4.5:1.

- **Reverse CW Key – (Software Menu item #8).** This feature enables the operator to quickly reverse the dit and dah sides of the paddle. This is convenient when one OP is left-handed and the other OP is right-handed.

DIGI MODES OPERATION

Most modern DIGI Modes should be run with the radio set to DIGI MODES. (Exception: RTTY). Defining how to set up DIGI Modes is beyond the scope of this manual. In general The only adjustment is the TX audio gain which is adjustable in **Software Menu item #20 (Gain TX DIGI)**.

RTTY OPERATION

RTTY is normally run in USB mode which enables it to take advantage of the radio's narrow filters. When running typical 170 Hz shift, you can use a bandwidth of 500 Hz (normal) or 250 Hz on a very crowded band. You must use filter F4 for this and adjust it manually. See example 3 on page 14.

AM / FM MODE OPERATION

In order to operate AM or FM Mode, you must first enable AM/FM Mode in the **Software Menu item #16**.

Use same speech adjustments in AM or FM Mode as described in SINGLE SIDEBAND Mode.

WARNING: Do not use the Speech Compressor in FM Mode.

MENU MODE SETTINGS

Menu Mode is entered or exited simply by pressing the MENU button (the top right button) on the front panel. Here you can change the settings of many of the radio's features and in most cases, monitor the changes as you are making them.

Version 1.2

Nr.	MENU	DESCRIPTION
0	Smart Valcoder	ENABLED: (normal mode), the VFO encoder changes its resolution (speed of tuning) as a function of how fast you turn the VFO knob. DISABLED: the encoder changes its resolution as a function of mode. Rotating the VFO one turn changes the frequency about 80 Hz in CW and 800 Hz in SSB.
1	Noise Reduction	Range 1 to 100. 1 is the lowest and 100 is the highest. When NR is activated while adjusting this value, you can hear the effect as you adjust. Use lowest level necessary in order to minimize audio distortion.
2	Pitch CW	Adjusts the frequency of the sidetone. When you set this to your preferred frequency, the CW Offset automatically adjusts to this frequency, assuring you are always zero beat when listening to this tone. Default is 720 Hz.
3	CW VOX	Controls the external amplifier's relay "hang time" (delay before switching back to receive). Adjustable in steps of 100 ms from 100 to 5 seconds. When disabled, the radio does not transmit when the key is pushed.
4	CW Type	Simple = Straight Key; Auto = Built-in Keyer
5	CW Speed	Adjusts the keying speed of the built-in keyer from 5 to 60 wpm. Changes take effect when you exit menu.
6	Iambic Mode	Toggles the built in keyer between iambic mode A and iambic mode B.
7	Weight CW Key	Adjusts the dot to dash ratio. Selections: 2:1, 2.5:1, 3:1, 3.5:1, 4:1, 4.5:1. Default is 3:1.
8	Reverse CW Key	Swaps sides for the dot and dash. Enables quick reversing of the key for swapping between right-handed and left-handed operators. Set to preferred position.

9	AGC RX	Adjusts the recovery speed of the receiver's AGC, from 1 (slowest) to 20 (fastest). Use slower speeds for SSB and faster speeds for CW. Set to preferred position for each mode. Default: 2.
10	Noise Blanker	When the noise blanker (NB) is activated by pushing "F" + "DOWN/NB", this adjusts the blanking. 4 is maximum blanking and 12 is minimum blanking. Set this value as high as possible while blanking is still effective. This minimizes audio distortion. You can listen to the changes in real-time as you adjust.
11	S-Meter Mode	This toggles the S-Meter between Bar Graph and uV readout. S-Meter is calibrated with PRE-AMP "ON".
12	TX Meter	Toggles readout between 'Bar Graph' and 'Output Power' displayed in Watts.
13	Show TX	Toggles readout between SWR and Output Power
14	Power TX	Adjusts 'Output Power' from 10 to 100. 10 is approximately 1W and 100 is approx. 5 to 8 Watts, dependant on the source voltage.
15	LED Mode	Toggles display's LED backlight between 2 positions: 'FOREVER' (always on) and 'AUTO' (on for 3 seconds each time a front panel control is adjusted). When light is off, it saves 40mA of current drain.
16	AM/FM Mode	Enables or disables display and selection of these two modes. When enabled, the mode button toggles through ALL modes. When disabled the mode switch toggles through SSB, CW and DIGI modes (only). This is individually adjustable and stored for each band.
17	Squelch FM	Adjusts the squelch sensitivity level for FM mode from 0 to 100. When set to 0, the squelch is essentially turned off.
18	Squelch SSB/CW	Adjusts the squelch sensitivity level for all modes except FM from 0 to 100. When set to 0, the squelch is essentially turned off.
19	SSB TX MUTE	The SSB TX 'Monitor' is enabled or disabled with this adjustment. "Enable" mutes this function. Also useful for setting
20	Gain TX DIGI	Adjusts the transmitter's 'AF Gain' in Digi Modes.

21	Voice VOX Level	Adjusts the VOX Gain (sensitivity) in SSB Mode from 10 (most sensitive) to 100 (least sensitive). For the original hand mic, use "80".
22	Voice VOX	(VOX DELAY) Select DISABLE (turns VOX OFF) or adjust delay from 100 ms to 5 sec. in steps of 100 ms.
23	Compress TX	Adjusts TX Speech Processor from 1 (minimum compression) to 100 (maximum compression). Always set to 40 to 50% when used with the factory Hand-MIC.
24	Reverberator	Adjust TX audio reveberation: Default: 'DISABLE'; Press RIT/XIT to toggle between 3 adjustments; Delay: '40ms', '80ms', or '160ms'; Depth: 1-7; Level: 1-7. Change value by rotating VFO knob.
25	EQ TX	Adjusts TX Audio Equalizer in 3 ranges, 'LOW' Frequencies, 'MEDium' Frequencies, and 'HIGH' Frequencies in steps from 1 (deemphasize) to 10 (maximum emphasis). Toggle between the 3 ranges by pressing the RIT/XIT button on the front panel. RECOMMENDED: LOW=10, MED=6, HIGH=6
26	EQ RX	Adjusts RX Audio Equalizer in 3 ranges, 'LOW' Frequencies, 'MEDium' Frequencies, and 'HIGH' Frequencies in steps from 1 (deemphasize) to 10 (maximum emphasis). Toggle between the 3 ranges by pressing the RIT/XIT button on the front panel.
27	Pan Level	Adjusts the 'Gain Level' of the Pan Adapter from 0 to 30. 30 = 60dB.

SOFTWARE MENU QUICK GUIDE

0	Smart Valcoder	10	Noise Blanker	20	Gain Tx DIG
1	Noise Reduction	11	S-meter Mode	21	Voice VOX Level
2	Pitch CW	12	TX Meter	22	Voice VOX
3	CW VOX	13	Show TX	23	Compress TX
4	Type CW key	14	Power TX	24	Reverberator
5	CW Speed	15	LED Mode	25	EQ TX
6	Iambic mode	16	AM/FM Mode	26	EQ RX
7	Weight CW Key	17	Squelch FM	27	Pan Level
8	Reverse CW Key	18	Squelch SSB/CW		
9	AGC RX	19	SSB TX MUTE		

=====

SERVICE MODE

=====

SERVICE MODE is a special maintenance mode where additional parameters may be adjusted. It is used for presetting general and unit-specific values of the radio. **Please contact Appello if you have any questions about this.**

WARNING:

Entering Service Mode RESETS MOST SETTINGS to their original DEFAULT VALUES. This includes all 27 of the Menu Mode Settings!

(Except for TX IQ, RX IQ and Synthesizer Calibration).

DO NOT TOUCH ANY SETTINGS in here unless you are 100% sure that you know what you are doing. Otherwise you may easily kill the radio's performance. PLEASE CONTACT APPELLO IF YOU HAVE QUESTIONS.

WARNING: WHEN IN SERVICE MODE, NEVER CHANGE THE VALUES OF "RX IQ" / "TX IQ" / "VFO" / "IF DSP" THEY ARE PRE-SET AT THE FACTORY FOR EACH INDIVIDUAL RADIO.

To Enable Entry to the Service Mode:

- Turn the radio **OFF**.
- Press and hold the **[F]** button, then power the radio **ON**.
- After the Aerial-51 logo appears on the screen, release the **[F]** button.
- You are now in Service Mode and may access the Service Mode Menu.

Functions of the Radio with Entry to Service Mode Enabled:

- **Do Nothing:** Normal Operation
- **Press [Menu]:** enters normal Menu Mode (just like normal operation)
- **Press [F] and then [Menu]:** Enters Service Mode
- **To EXIT Service mode, TURN RADIO OFF.** Restart radio as normal.

ALWAYS EXIT SERVICE MODE AS SOON AS YOU HAVE
FINISHED MAKING CHANGES TO THE MENU ITEMS.

This helps avoid making accidental changes to menu items.

SERVICE MODE Continued:

DO NOT TOUCH ANYTHING in here unless you are 100% sure that you know what you are doing. Otherwise you may easily kill the radio's performance.

GENERAL INFORMATION ABOUT SERVICE MODE	
Each time you "ENABLE ENTERING SERVICE MODE" (by pressing [F] while powering on the radio) most parameters are automatically reset to their DEFAULT VALUES:	
DEFAULT VALUES	VFO = {12345678} (Unit-Specific; DO NOT TOUCH IT!)
	S-METR = {xx} (Unit-Specific; DO NOT TOUCH IT!)
	IF DSP = {5149} (firmware-specific value - DON'T TOUCH!)
	FILTER TX CW = 100
	FILTER TX FM = 9600
	FILTER TX AM = 5590
	Vpwr = 0
CAT - FTDI FT232RL	

BAND-SPECIFIC PARAMETERS			
Several parameters must be set separately for EACH BAND. There are 11 different bands. You must select the band BEFORE entering the Service Menu. You must also exit the Service Mode Menu in order to change bands. When exiting and re-entering, don't forget to press [F] then [MENU] . The current BAND is indicated by a number following the name of the menu item. (i.e. Port 3 means Port for BAND 3). The band specific Menu items are shown below with " # " to indicate that a band number will be shown. The list below shows you the band number of each band.			
BAND #	0 = 160m	4 = 30m	8 = 12m
	1 = 80m	5 = 20m	9 = 10m
	2 = 60m	6 = 17m	10 = 6m
	3 = 40m	7 = 15m	

SERVICE MODE MENU ITEMS	DESCRIPTION / COMMENTS
IF DSP	Virtual gap frequency from 5006 to 10013 Hz. Recommended to use low-frequency virtual IF. No need to ever change this value. DO NOT TOUCH IT.
V PWR	Adjustment of displayed voltage
REF VFO	For correcting the VFO frequency. This parameter is unit-specific for each radio. DO NOT TOUCH IT.
MULT VFO #	Divider VFO. DO NOT TOUCH IT.
BEGIN FREQUENCY #	Sets low end starting frequency for each band. Must select band <u>before</u> entering Service Mode Menu. Set the frequency with VFO knob. Note: you must exit Service Menu to change bands, then re-enter Service Menu to set the next band.
END FREQUENCY #	Sets the stop frequency for the high end of each band. Must select band before entering Service Mode Menu. Set the frequency with VFO knob. Note: you must exit Service Menu to change bands, then re-enter Service Menu to set the next band.
PORT #	(Band Ports) These port settings tell the radio which bandpass filter and low-pass filter to use for each band. DO NOT TOUCH IT.
S METER	Used for calibrating S-Meter Range. DO NOT TOUCH IT.
RX IQ #	Setting the mirror channel correcting the phase and amplitude of IQ for each band separately on RX - minimum reading – has two modes- fast and slow for quick setting and fine – switched with STEP. DO NOT TOUCH IT.
FILTER SSB	Enables the adjustment of the high and low cut-off frequency for each of the first three SSB filters. The range is 150 Hz to 3600 Hz. Select filter to be adjusted by pressing the "Filter" button. Select high or low frequency with "RIT" button. Change cut-off frequency with the VFO knob. Note: Filter 4 is adjusted within the normal menu mode (not in service mode). NOTE: Use with the factory hand-mic may require setting lower band-stop to 150 Hz.
FILTER CW	Adjusts the bandwidth of the first three CW filters. The range is 50 Hz to 2400 Hz. Change bandwidth by rotating the VFO knob. Pressing the FILTER Button toggles through filters 1, 2, & 3. Note: Filter 4 is adjusted within the normal menu mode (not in service mode).

SERVICE MODE Continued:

Filter AM	Adjusts the bandwidth of the first three AM filters. The range is 2000 Hz to 9600 Hz. Select filter to be adjusted by pressing the "Filter" button. Pressing the FILTER Button toggles through filters 1, 2, & 3. Note: Filter 4 is adjusted within the normal menu mode (not in service mode).
Filter FM	Adjusts the bandwidth of the first three AM filters. The range is 2000 Hz to 9600 Hz. Select filter to be adjusted by pressing the "Filter" button. Pressing the FILTER Button toggles through filters 1, 2, & 3. Note: Filter 4 is adjusted within the normal menu mode (not in service mode).
AGC DSP	(On/Off) AGC should always be set to "ENABLE"
SHOW S METER	Switches S-Meter
FILTER TX SSB	Adjustment of transmit bandwidth in the SSB mode. Values can be selected from 150 Hz to 3600Hz.
FILTER TX CW	Adjustment of transmit bandwidth in the CW mode. Values can be selected from 50 Hz to 1000Hz.
FILTER TX AM	Adjustment of transmit bandwidth in the AM mode. Values can be selected from 200 Hz to 9600Hz.
FILTER TX FM	Adjustment of transmit bandwidth in the FM mode. Values can be selected from 200 Hz to 9600Hz.
LEVEL TX #	{1234} DO NOT TOUCH IT.
POWER TX #	{0} {123} DO NOT TOUCH IT.
TX IQ #	Setting the mirror channel correcting the phase and amplitude of IQ for each band separately on TX - minimum reading – has two modes- fast and slow for quick setting and fine – switched with STEP. DO NOT TOUCH IT.

In the rare event that you manage to blow out some or all of the factory presets, **please contact Appello.** The general and unique parameters of your specific radio (by serial number) must be re-entered manually. This work takes about one hour.

Appello GmbH

Koenigsfoerderstr. 32

24214 Lindau/Kiel

GERMANY

Info@appello.de



**The SKY-SDR Concept and Design
were created by LZ2TU, RA9YTJ, & LZ1JY
MADE IN EUROPE**